

Treasure

Talk SA

Febr - March 2017

Beeld

Northglen
News

The Times

facebook



**2,300-year-old sword
discovered
Still shiny and lethal**

HONOURABLE MENTION
FOUR NAME RING
NOVEMBER 2016



Donald Ensor

"Those things which are precious are saved only by sacrifice"
David Kenyon Webster



TREASURE QUEST TREASURES

METAL DETECTORS & ACCESSORIES



TEKNETICS
HIGH PERFORMANCE METAL DETECTORS



MAKRO
METAL DETECTORS



Nokta
DETECTION TECHNOLOGIES



Metal Detector Calls
KARMA

Metal Detectors
Pin Pointers
Beach Sand Scoops
Relic Spades
Hand Diggers
Rock Diggers
Treasure Hunting Books
Coin Tumblers
Raptor Scoop Handles
Back Packs
Ear Phones
Treasure Hunting



LET THE ADVENTURE BEGIN

WEB: www.treasurequesttreasures.co.za

EMAIL: info@treasurequesttreasures.co.za

 TREASURE QUEST TREASURES

 Group: Treasure Quest - Treasure Hunting & Metal Detecting

PHONE: 083 366 9445 / 072 297 7833



QUALITY PRODUCTS



Now exporting worldwide.

Products also available at



FROM THE EDITOR VAN DIE REDAKTEUR



tydag 2 Desc

Beeld | Jou wêreld, jou koerant

.Nuus 3

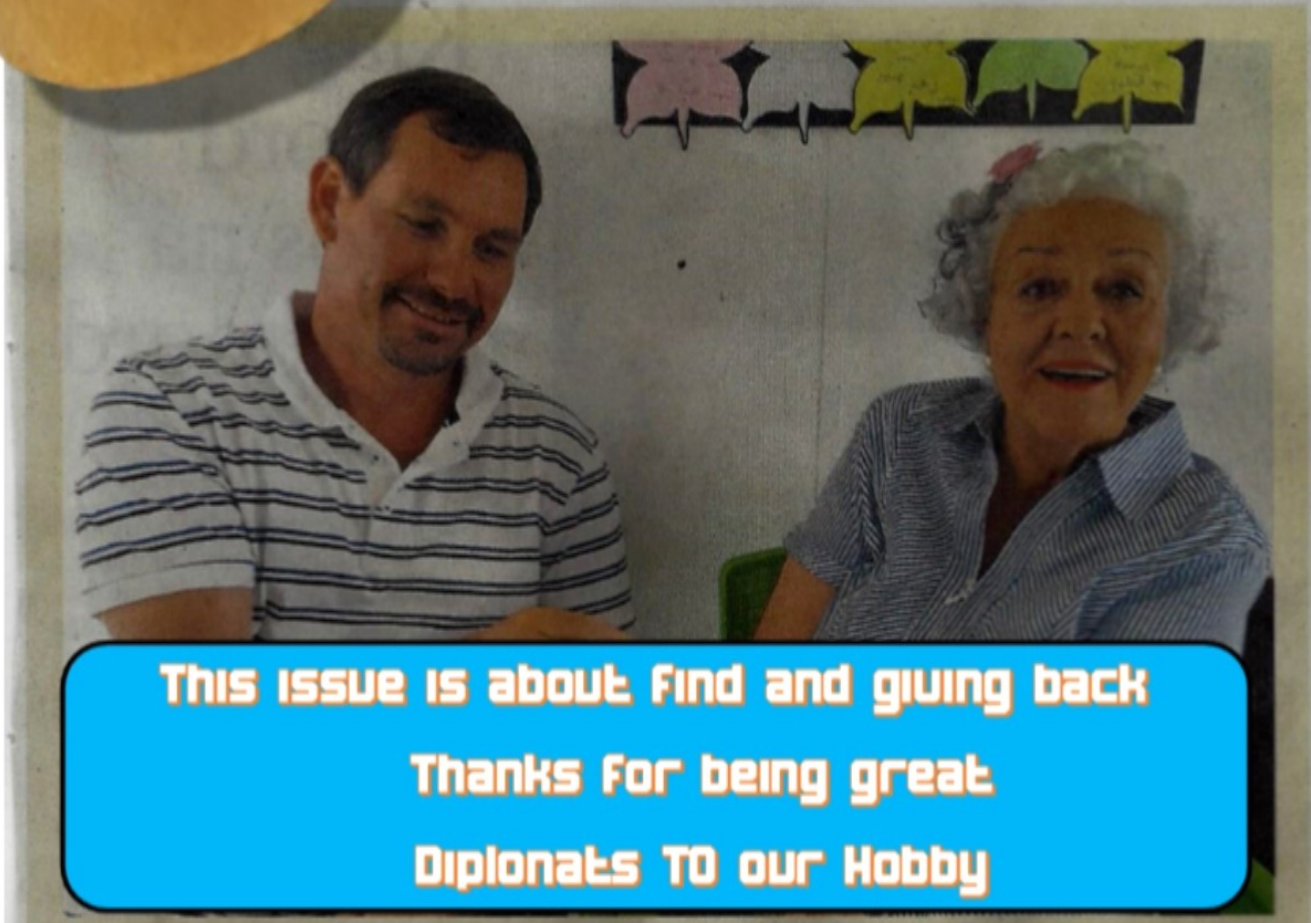

**This issue is about find and giving back
Thanks for being great
Diplomats TO our Hobby**



SUPPORT OUR ANNUAL HUNTS

Contents / Inhoud

Donald Loner Metal Detector SA Club

October 2016



facebook

Donald Loner - Metal Detector SA Club

October 2016

Last week's gold from a beach that I thought I had cleaned. Two weeks ago a huge washout occurred and I hunted and recovered over 10 items of gold jewelry. The sun burned and heated the area so with sand I checked this spot every morning for a week on Fridays now tide I noticed a depression low down close to the water. There was plenty of old iron and brass fittings on and around it. In 15 minutes I had a bag of assorted brass fixtures and two thin beads. I shifted what was left and returned the following day, more brass fittings. The rings one inscribed with names and dates. And two men's 9ct wedding bands, quickly found themselves in my bag.

Day 3 gold fever 5 gold rings 1 being 18kt and weighing in at 14.4 grams unfortunately the huge stone is a cubic.

The 4 day was my best hearing day ever two 9ct rings a 9ct 5 pendant and a 10 Krugger coin unbelievable. My first gold coin.

Day 5 one small 9ct ring which got broken on my bag. The depression on the beach was still there. Still with sand.

Day 6 it was a good day. I went back to the beach to see if there were any other items. About 10 items. 2 pieces of religious items and other items. The 1928. Our first has been a great month for me. Just started my first year.

Page 7

'Homicide Detective' - William Faurie

The story is that a man was killed at gun point on a road about 100m from a small area of land. The man's name was William Faurie. He was a police officer and was killed on the ground and stopped at the scene. The man's name was William Faurie. He was a police officer and was killed on the ground and stopped at the scene. The man's name was William Faurie. He was a police officer and was killed on the ground and stopped at the scene.



The only evidence that was recovered before went to the scene was a spent casing from the murder. When I went to the scene I found the casing had landed on the ground near the water as a part of the casing. I was able to locate it 10 minutes after I started looking within 10 minutes. I was a huge success. The suspect that the police were looking for was found. The suspect that the police were looking for was found.

Page 12

31st Annual
Free State Treasure Hunt
2 - 8 September 2016

Come Experience the Friendly Free State
Page 14

doculam
GARRETT METAL DETECTOR

Page 7

Giving Back a Lost Ring !

Page 12

Homicide Detective

Page 14

Annual Hunt 2016

The views expressed in Treasure Talk SA are not necessary those of the editor , staff or publisher

Contents / Inhoud

facebook 



Page 20



Page 29



Page 31

Expedition Unknown – The African Gold Hoard – South Africa

Published November 28, 2013 by Expedition Unknown



Page 29



Incredible moment archaeologists pull out a 2,300-year-old sword and discover it's still shiny and lethal

Chinese archaeologists were surprised to discover that an ancient sword they had unearthed were in near perfect condition.

Last Friday, experts pulled out the blade from its scabbard and realised that the 2,300-year-old relic was shiny and sharp.

The traditional Chinese weapon was found inside an ancient coffin in Henan Province in central China, where the Chinese civilisation is thought to have originated.



Page 31



Page 20

The "TICKEY"

Page 29

African Gold

Page 31

2,300 YEAR OLD SWORD

The views expressed in Treasure Talk SA are not necessary those of the editor, staff or publisher

You Can send your Story under these Headings

Field Test



Treasures in the Headlines

BREAKING NEWS

Beach Finds



Coins



War Relics



Dump Digging



Club News



More about my Find ?

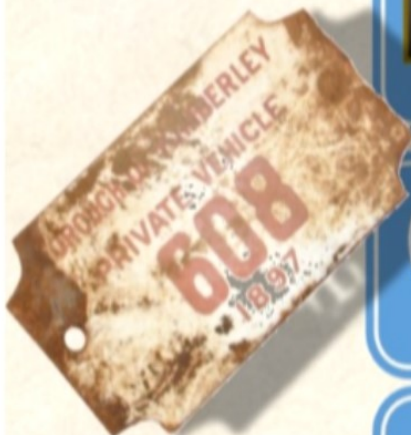

Donald Ensor Metal Detector SA Club

October 20, 2016 ·



In the news

BREAKING NEWS

facebook



Donald Ensor to Metal Detector SA Club

October 20, 2016 ·

Last weeks gold from a beach that I thought I had cleaned, Two weeks ago a huge washout occurred and I hunted and recovered over 10 items of gold jewelry. The sea turned and buried the area in soft sand I checked this spot every morning for a week on Fridays low tide I noticed a depression low down close to the water, there was plenty of old Iron and brass fittings in and around it. In 15 minutes I had a bag of assorted brass fixtures and two thin bands, I shifted what iron I could and returned the following day, more brass fittings 2, 18ct rings one inscribed with names and dates. And two men's 9ct wedding bands, quickly found themselves in my bag.

Day 3 gold fever 5 gold rings 1 being 18ct and weighing in at 14, 4 grams unfortunately the huge stone is a cubic.

The 4 day was my best hunting day ever two 9ct rings a 9ct S pendant and a 1/10 Kruger coin unbelievable. My first gold coin.

Day 5 one small 9ct ring which got broken in my bag, The depression on the beach was slowly being filled with sand.

Day 6 it was completely covered over and I moved back to searching other beach's. Along with the gold I also found a few silver pieces some religious items and coins, one being the Portuguese coin dated 1928. October has been a great month for me, just shows you what is out there.

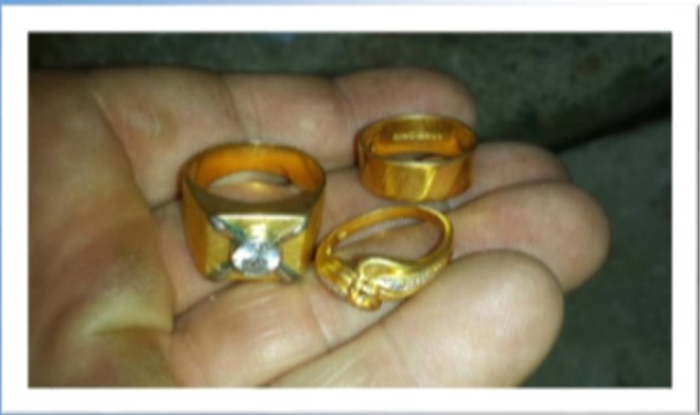

Mysterious ring saga comes full circle



Donald Ensor with the gold men's wedding band.

THE ring that caused a social media frenzy will be handed over to its rightful owners at the end of this month. The gold men's wedding band was lost along a Durban beach, more than 20 years ago.

La Lucia detectorist, Donald Ensor stumbled across the ring during one of his routine beach detector sessions. Noticing that the ring was engraved with two wedding dates, the enthusiastic metal detectorist took to his Facebook page, in the hopes of tracking down the owners. According to Ensor, the band was engraved with the names of two couples (Tom and Lyn and Brent and Peggy). **The ring also has a 1960 wedding date on the inside.**

Ensor's post was shared 4 000 times, attracting hundreds of comments. According to Ensor, he was contacted by a woman on **Facebook**, saying that the ring belonged to a relative of hers.

"She asked for my contact number and handed it to Brent, whose name appears on the ring. He phoned me and was excited that the ring was found," he said. Brent was able to correctly identify the exact dates engraved on the ring. Brent told Ensor that the ring was lost more than 20 years ago during a fishing trip in Durban. It was given to him by his mother, when his father passed away. "Brent said when the ring fell into the water, he just figured it was gone," Ensor said. Ensor said he was grateful to the thousands of people who shared the initial post. "It is because of them the ring will be returned to the rightful owners. I am very excited that the ring will be reunited with Brent," Ensor said.



Long-lost wedding ring finds way home after 20 years

2016-11-24 12:47

Durban – The owner of the lost wedding ring found after 20 years on a KwaZulu-Natal beach this week is ecstatic.

Brent Lucas, from Mtubatuba, had been angling and when he washed his hands, the ring slipped off.

"It's a ring that I got from my mother before I got married. It had belonged to my dad and she gave it to me after he'd died," Lucas said.

The names of his parents, Tom and Lyn, as well as their wedding date – October 1, 1960 – initially had been engraved on the ring.

The names of Lucas and his ex-wife, Peggy, as well as the date on which they got married, were later engraved on the ring.

'Special' ring

Lucas said after he'd lost the ring, he kept hoping that someone would find it someday. He said he can't remember when he and Peggy got married, but his memory will be jolted soon when he gets the ring back.

He and Peggy divorced 15 years ago. "I'm glad that the ring has been found after so many years," he said. Local resident Donald Enson, who looks for metal as a hobby, found the ring on the Durban beach this week.

"There are so many things that made the ring special that I had to find the owner," Enson said. He'd posted photo and description of the ring on Facebook and asked friends to share it. A relative of Lucas' saw the photo and contacted Enson. Lucas confirmed the names and dates on the ring.

He will likely fetch the ring from Enson on Monday.



Donald Ensor oorhandig die trouwing wat 21 jaar gelede in die see vermis geraak het aan die oorspronklike eienaar, Lynette Lucas. "Dit gaan nie goed met my ma nie en sy sê die trouwing van haar oorlede man wat sy nou terug het, gee vir haar krag en herinner haar aan my pa". Só sê Jackie Lortan, Lynette Lucas se stiefdogter. Die ring, wat verlede week ná 21 jaar op 'n strand in Durban gevind is, is Woensdag aan haar teruggegee. Lucas het haar trouwing 23 jaar gelede laas gesien nadat sy dit aan haar seun, Brent, gegee het voordat hy getroud is. Dit was nadat Tom, sy pa, oorlede is. Tom en Lyn se name en troudatum – 1 Oktober 1960 – was aanvanklik op die ring gegraveer. Brent is destyds met Peggy getroud en hul name en troudatum is jare later óók op die ring gegraveer. Brent en Peggy is intussen geskei. Volgens Lortan het Lucas nooit geweet dat die ring weg is nie, totdat dit na al dié jare gevind is. "Brent het dit nooit aan haar vertel nie. Ek het wel geweet dat dit weg is." Brent het in die see visgevang en toe hy sy

hande was, het sy ring van sy vinger afgegely. Lortan sê dit is maar 'n familieding omdat haar man, Adrian Ren, ook sy ring in die see verloor het toe hy visgevang het. "Ek is dankbaar dat my ring ná soveel jare gevind is," sê Brent. Donald Ensor van Durban, wat as 'n stokperdjie na metaal soek, het verlede week die trouwing gevind. "Daar is so baie dinge wat die ring spesiaal gemaak het. Ek moes net die eienaar daarvan opspoor," sê Ensor. Hy het op Facebook 'n foto van die ring geplaas en daarby 'n inskrywing gemaak wat die ring beskryf. Ensor het dit verlede Maandag op Facebook geplaas en sy vriende gevra om dit te deel. Dit het daartoe gelei dat 'n familielid van Brent die foto gesien en Ensor gekontak het. Brent het die name en datums op die ring aan Ensor bevestig. Hy kon nie self die ring by Ensor kry nie omdat hy in Mtubatuba werk. Ensor het toe die ring by die Mary Asherouetehuis in Durban aan Lucas gaan oorhandig.

'Homicide Detective' - William Faurie

The story is that a man was robbed at gunpoint on a well used footpath in a rural area of Ladysmith. The man -whose name is withheld for privacy purposes- was forced to lay on the ground and stripped of his belongings. When asked if he was armed he said yes and was shot 3 times, once in his hip the once in his chest and the most fatal one through the head. They took his weapon and fled the scene leaving an eye witness who was a friend of the victim, lying on the ground in fear. The eyewitness fled the scene when he saw the killers coming back for him.

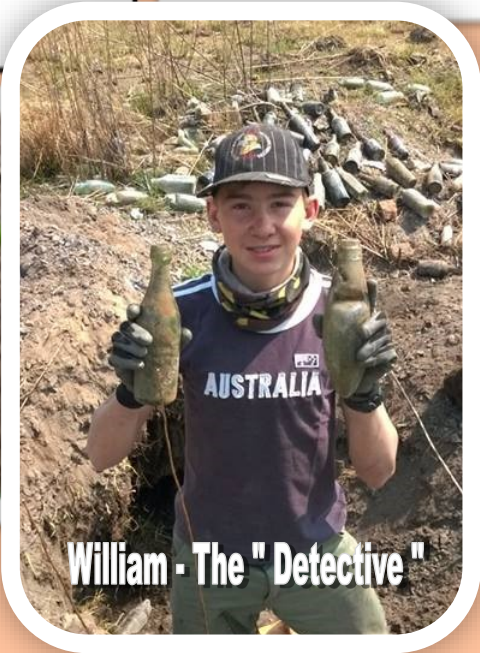

William - The " Detective "



The only evidence that was recovered before i went to the scene was a spent casing from the murder. Upon arrival i saw that the family of the deceased had removed all the blood from the scene as a part of tradition. I was able to locate all 3 bullet heads and 1 more spent casing within 10 minutes. It was a huge success. We suspect that the third casing was mixed in with the blood the family took away.

The detectives were able to arrest the suspects and recover the weapon used to kill the man two days after i helped out. My evidence will hopefully help to put those criminals away for a long time.

This was by far my most successful hunt and a very interesting one at that.



Northglen News

18 November 2016



Donald Ensor with this detector and

Meet Durban North's treasure hunter

MEET Donald Ensor, Durban North's very own treasure hunter. Ensor made headlines last week when he found a men's 18ct gold wedding band. The band, bearing two wedding dates and four names, caused quite a stir on social media with his post having been shared more than 1000 times across community groups.

Northglen News chatted to Ensor to find out more about his passion for treasure hunting and his most interesting find to date.

Ensor said he has always had a penchant for 'searching for treasure along the beachfront' but it was only three years ago that he decided to take it up as a serious hobby.

He said his detectorist spark began to flicker during a walk to the beach in Umhlanga Rocks and seeing another detectorist, who found a Sovereign.

Since then, Ensor has been walking the Durban beaches, from Shaka's Rock to the uShaka beachfront for the last three years.

"Of all the items I've found, I would say a World War II Polish medal that was awarded in 1944 has got to be the most interesting thing," he said.

Armed with his detector machine, Ensor has stumbled across a wealth of finds. In his garage, there are large containers with thousands of coins that have spent many months, maybe even years, hidden either in rock pools along the beach or under the sand. He also has an array of fishing sinkers, diamond rings, gold jewellery, titanium rings and South African coins that date back to before he was even born.

Ensor explained that he has always lived along the coast.

"When I was a kid, I used to go diving for tackle, sinkers and I'd find the odd ring. I spoke



Se-Anne Rall
seanner@dbn.caxton.co.za

www.northglennews.co.za

to guys with detector machines and after seeing a youngster with his machine walking along Umhlanga Rocks beach, pick up a Sovereign, the bug bit," he said.

"I usually spend about two hours on the beach just looking for stuff. Some days, there are lots to find and on other days, you can search and search and find nothing," he said.

Ensor keeps a close eye on the weather patterns. Usually a windy night means a shift in sand or perhaps a collapsed sandbank, which can reveal a wealth of treasure.

Once he's gathered his find for the day, Ensor salvages what he can by letting the items, stand in a mixture of water and vinegar. Once cleaned, if it's jewellery, he has it evaluated. The coins usually get handed over to a buddy of his who runs a museum or gets carefully stored away in his garage.

"Over the three years, I've found a number of fishing and camping items as well as coins and jewellery. I'd rate finding a Kruger coin as one of most treasured finds and I also found a ring that dates back to the 1900s."

When Ensor isn't out on the beach searching for treasure, he can be found managing his business.

For Ensor, being able to go out and search for 'treasure' is fun and gets him out of the house to enjoy the sunshine.

"Well it's better than sitting in a pub," he said.

Mysterious ring saga comes full circle

THE ring that caused a social media frenzy will be handed over to its rightful owners in a few days time. The gold men's wedding band was lost along a Durban beach, more than 20 years ago. La Lucia detectorist, Donald Ensor stumbled across the ring during one of his routine beach detector sessions.

Noticing that the ring was engraved with two wedding dates, the enthusiastic metal detectorist took to his Facebook page, in the hopes of tracking down the owners. According to Ensor, the band was engraved with the names of two couples (Tom and Lyn and Brent and Peggy). The ring also has a 1960 wedding date on the inside. Ensor's post was shared 4 000 times, attracting hundreds of comments.

According to Ensor, he was contacted by a woman on Facebook, saying that the ring belonged to a relative of hers, who lives in uMtata.

"She asked for my contact number and handed it to Brent, whose name appears on the ring. He phoned me and was excited that the ring was found," he said. Brent



Donald Ensor with the ring that will be handed over to its rightful owner, 20 years after it was lost during a fishing trip.



Se-Anne Rall
seanner@dbn.caxton.co.za

www.northglennews.co.za

was able to correctly identify the exact dates engraved on the ring. Brent told Ensor that the ring was lost more than 20 years ago during a fishing trip in Durban. It was given to him

by his mother, when his father passed away.

"Brent said when the ring fell into the water, he just figured it was gone," Ensor said.

Ensor said he was grateful to the thousands of people who shared the initial post.

"It is because of them the ring will be returned to the rightful owners. I am very excited that the ring will be reunited with Brent," Ensor said.

HONOURABLE MENTION

FOUR



Donald Ensor

"Those things which are precious are saved only by sacrifice"

David Kenyon Webster

31st Annual Free State Treasure Hunt 2 - 8 September 2016



Come Experience the Friendly Free State

Thanks to our Sponsors

Contact :
Lukas van der Merwe
0820727747
ZAR.skattejagters@gmail.com

doculam
IDENTIFICATION, SECURITY, SAFETY SOLUTIONS & EVENTS

GARRETT METAL DETECTORS
50 YEARS
1964-2014

GARRETT
METAL DETECTORS



Wednesday 7 September 2016 Community Work



This was an early day when the Crew went back to a site that we didn't hunt the day before. The owner didn't get up early so they had to come back to base. Lukas , Eugene . Tanya and Piet met at the Printers at Heilbron to put up the name tags for displaces donated back to our Farmers.



Giving Back to Heilbron's Farmers and Museums

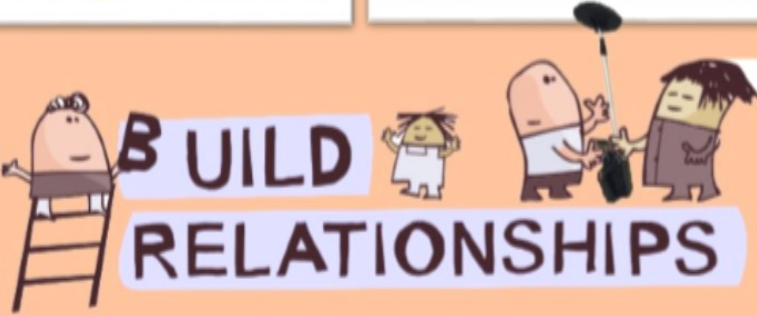



Wednesday 7 September 2016 First Session

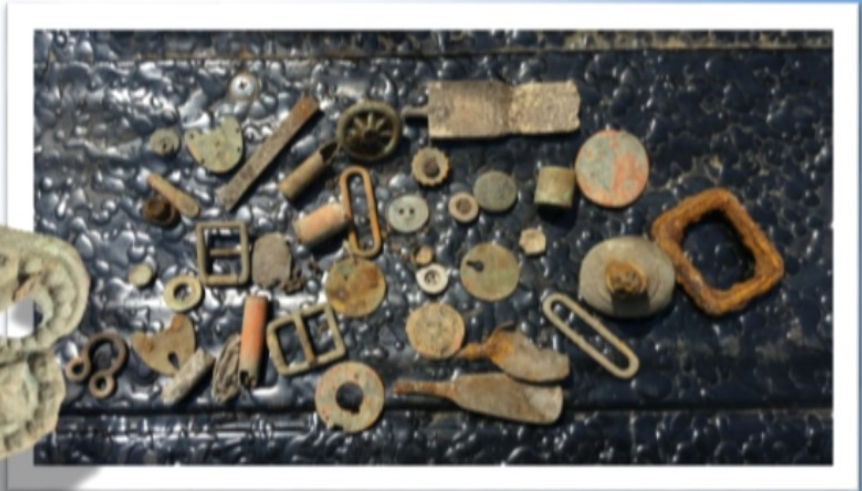



Wednesday 7 September 2016 Second Session



Nice old buildings and still a lot to explore



NO WONDER I FIND SO MANY
They're mating down there!





Wednesday 7 September 2016 Best Finds for the Day!



Day 5 - Best Finds Winner - David



Day 5 - 2nd Best Finds Winner - Fred



Lucky Draw Winner - Greg



Day 5 - 3rd Best Finds Winner - Greg





Thursday
8 September 2016
First Session of last day



The last day THE CREW were Hunting at the British Camp at the Heilbron Golf Coarse where some nice relics where found. They closed it for us and yes....the greens were out of bounce.....!





THE SILVER TREEPENCE
 (Fondly referred to as "TICKEY" by South Africans)
 1937 to 1952 KING GEORGE VI SERIES
 1951 6 325 388 were minted - Silver content 0.71 gm



David Pienaar Ticky ?



Warren Arnold Hill 3 penny .. Thrupence



David Pienaar 3 pence



Donald Ensor Nice find Zorgs



Andre Robberts 3 pence/3peny/Tickey



Shane Ebley tickey ! The full coinage was : 4 farthings (quarter of a penny) to a halfpenny (ha'pen-ny,) two ha'pennys to a penny, three pennys to a ticky (thrupenny or thrupence) two tickeys to a six-pence , two sixpence to a shilling 20 shillings to a pound. 21 shillings in a guinea. there for to a Pound you got 960 farthings, 480 halfpennys, 240 pennys, 80 tickies, 40 sixpences, 20 shillings . ALSO there was A Florin equalled two shillings (called two Bob) it does not end there !! BUT imagine doing division and multiplication with these !!! I did



Roy Marlow 50% silver.





Thursday 8 September 2016



Thursday
8 September 2016
Best Finds for the Day

Day 6 - Best Finds Winner - Greg

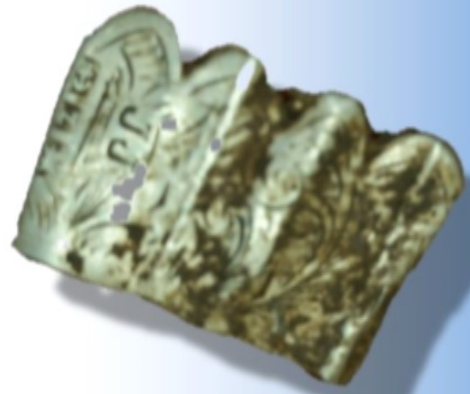

Day 6 - 2nd Best Find - David

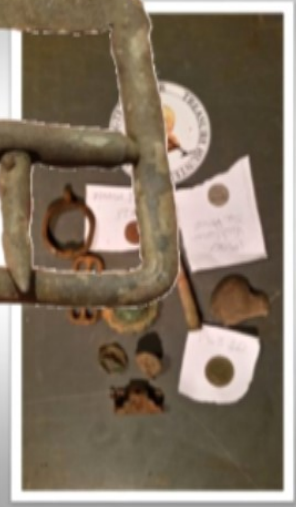

Day 6 - 3rd Best Finds Winner - Wade



Best Crew Hunters Annual Hunt 2016



1ST

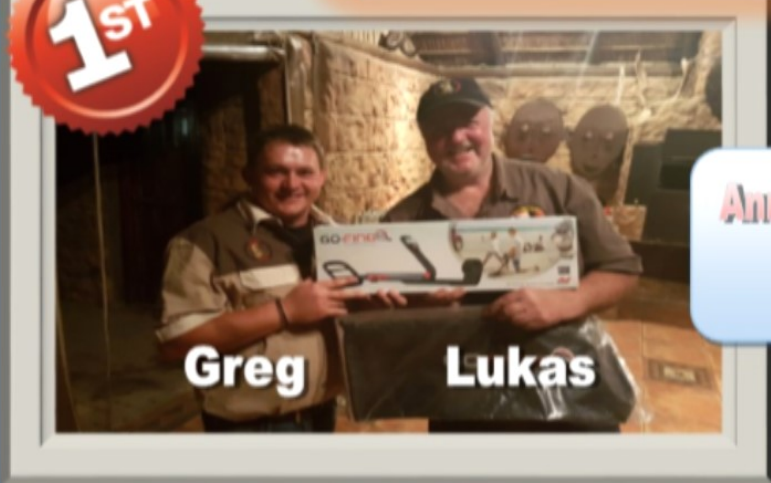

Greg Lukas

Annual Hunt 2016 - Best Finds Winner
Greg

Annual Hunt 2nd Best Find Winner - David



David Lukas



Annual Hunt 2016 - 3rd Best Finds Winner
Lana

3RD
PLACE



Lana Lukas

Thanks
to our
Sponsors

Great Crew....Great Finds...!

Metaalverklikkers besoek Heilbron

'n Groep wat na hulself verwys as Metaalverklikkers het van 2 tot 8 September kom kuier in Heilbron waar hulle oorblyfsels opgespoor het met metaalverklikkers. Hulle doen dit al vir 31 jaar, waar hulle elke jaar in 'n ander omgewing gaan soek. Die groep wil teruggee aan die gemeenskap en ondersteun die genieskap deur gebruik te maak van byvoorbeeld gaste-huise en ander dienste wat die dorp bied.

Hulle het op die gholfbaan in Heilbron 'n hele paar historiese goedere gevind. Vir dié wat nie weet nie, die gholfbaan was 'n Britse kamp in die vroeë 1900's. Hulle het ook op die Vegkop slagveld gaan soek waar hulle ook paar historiese goedere opgespoor het. Die doel van hierdie groep is om die geskiedenis te bewaar en te sorg dat die goedere nie verkoop word nie, maar in die gemeenskap bly waar dit gevind is. Die oorblyfsels wat gevind is, is in 'n houtkas gebêre. Mnr John Watson het namens die Gholfklub die kas met Britse oorblyfsels ontvang en mev Quarta Pretorius het die kas met Vegkopoorblyfsels ontvang wat in die museum vertoon sal word.

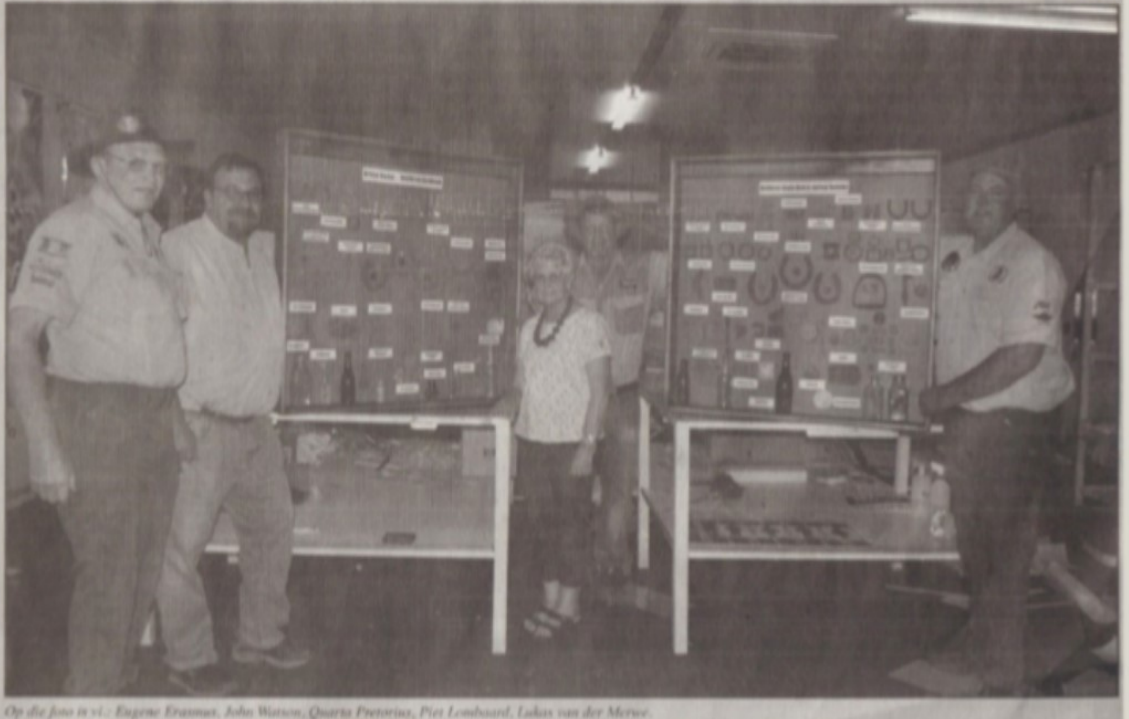

Op die foto in vl.: Engene Erasmus, John Watson, Quarta Pretorius, Piet Lombard, Lukas van der Merwe.

PLEASE SUPPORT OUR ANNUAL PROVINCIAL HUNTS 2017

32 nd Annual Hunt!
Eastern Transvaal Crew
2017
29 Sept - 4 Oct 2017

Experience the Treasures of the Eastern Transvaal

Contact: Sheila Pienaar
 012 371 8406
 Email: sheila@easterntransvaal.com

32 ND ANNUAL HUNT
FREE STATE CREW
2017
1 - 7 September

4th CONSECUTIVE YEAR
AND ONLY TOUCHED THE SURFACE

Experience the Friendly Free State

Contact: 082 068 1760
 freestatecrew@gmail.com

32 ND ANNUAL HUNT
EASTERN GAPE FRONTIER WAR HUNT CREW
1 - 4 SEPTEMBER 2017

If you got "Cuts" join us!

FRONTIER WARD

Contact: 082 068 1760
 frontierwarhunt@gmail.com

32 nd Annual Hunt

Eastern Transvaal Crew

2017

29 Sept - 4 Oct 2017



Experience the Treasures of the Eastern Transvaal



Thanks to our sponsors

Contact :David Plenaar
072 771 8146
Plenaar.Bertus@columbus.co.za



HONOURABLE MENTION

The Honourable mention will be awarded to members who use our hobby to help others but guided by the example set by David Kenyon Webster. A picture with a purple ring will be presented to the person receiving the Honourable mention. This will be based on the following example and will be used as guideline to award this.

Honourable Mention:

“Those things which are precious are saved only by sacrifice” David Kenyon Webster.

Private First Class David Kenyon Webster (June 2, 1922 - September 9, 1961) was an American soldier, journalist and author. During World War II he was a private with Easy Company, 2nd Battalion, 506th Parachute Infantry Regiment, in the 101st Airborne Division.



Author Steven Ambrose had this to say about Webster: "... Various officers wanted to make him a squad leader, but he refused. He was there to do his duty, and he did it - he never let a buddy down in combat - but he never volunteered for anything and he spumed promotion".

David Kenyon Webster was awarded the Purple Heart for his service in WWII. For me his quote above is the essence of something worthy of an Honourable Mention and his life reflective of people who deserve it. He was humble to the point of turning down promotions; he never volunteered for valour, but did his duty. For many the WWII film, "Band of Brothers" is their connection to David Kenyon Webster.

Those things which are precious are saved only by sacrifice

David Kenyon Webster

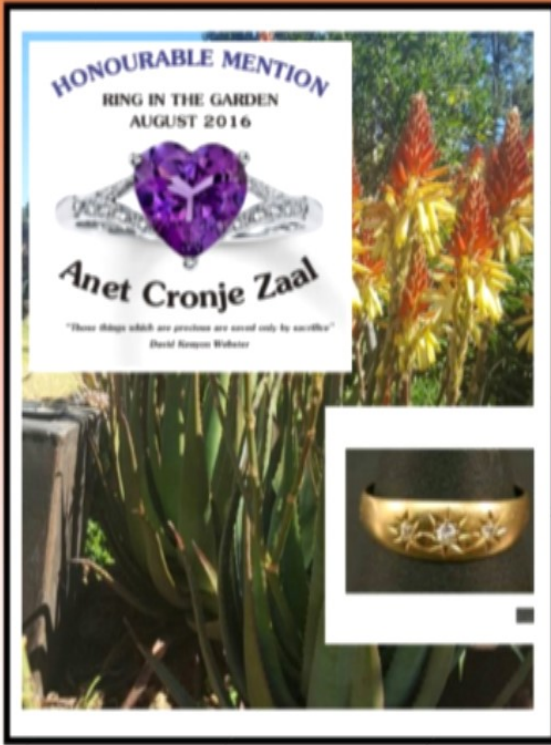

Found my first gold ring after 2 years of trying.
 Couldn't keep it.... belonged to a lady who lost it while gardening. She's been wearing it for 48 years..
 In exchange I received this beautiful aloe...

"I'm glad that the ring has been found after so many years,"



Lost ring back with his owner my first find to be returned.

Went to help a friend who had lost her ring in her Garden a year ago. Took us about 25min to find it in a flower bed.

Adrian Munro That's so nice of you...we all need to respect owners of items and properties of owners with our finds.



I WILL ALWAYS CHECK LOCAL LAWS BEFORE SEARCHING. IT IS MY RESPONSIBILITY TO “KNOW THE LAW “

I WILL RESPECT PRIVATE PROPERTY AND WILL NOT ENTER PRIVATE PROPERTY WITHOUT THE OWNER’S PERMISSION. WHERE POSSIBLE, SUCH PERMISSION WILL BE IN WRITING.

I WILL TAKE CARE TO REFILL ALL HOLES AND TRY NOT TO LEAVE ANY DAMAGE.

I WILL REMOVE AND DISPOSE OF ANY AND ALL TRASH AND LITTER THAT I FIND.

I WILL APPRECIATE AND PROTECT OUR INHERITANCE OF NATURAL RESOURCES, WILDLIFE AND PRIVATE PROPERTY.

I WILL AS AN AMBASSADOR FOR THE HOBBY, USE THOUGHTFULNESS, CONSIDERATION AND COURTESY AT ALL TIMES.

I WILL WORK TO HELP BRING UNITY TO OUR HOBBY BY WORKING WITH ANY ORGANIZATION OF ANY GEOGRAPHIC AREA THAT MAY HAVE PROBLEMS THAT WILL LIMIT THEIR ABILITY TO PEACEFULLY PURSUE THE HOBBY.

I WILL LEAVE GATES AS FOUND.

I WILL BUILD FIRES IN DESIGNATED OR SAFE PLACES ONLY.

I WILL REPORT TO THE PROPER AUTHORITIES ANY INDIVIDUALS WHO ENTER AND OR REMOVE ARTIFACTS FROM GRAVES AND MONUMENTS.

Join the
Historical Metal Detectives SA
Today

hmdrsa@gmail.com

Expedition Unknown – The African Gold Hoard – S02E11

Published January 28, 2016 | By [RottenOne](#)

For our next exciting adventure we're off to Africa in search



of gold. Josh is on the trail of gold coins that were buried at the behest of Paul Kruger when he fears the loot will fall into the hands of the invading British. To secure the wealth of his fledgling republic, Kruger stashes the coins on a train wherein the gold and all records of it are lost. But there are a few new leads and several new groups out looking for the gold which could be worth nearly a billion dollars in today's money.

Paul Kruger was the president of a small republic in the very early 1900s. His group had found a wealth of gold in Africa and had been using it to mint coins. Trouble erupted in the area which ultimately lead to the Boer's War. Sensing trouble and not

wanting to lose his newly minted wealth, the coins are loaded on a train so that Kruger and the loot can exit the country. They leave Pretoria by train and head for Machadodorp. That was the last time the gold was scene. Kruger leaves the country, but he never meets up with his gold reserves.

The first order of business is to follow the money. Josh follows the route to the last place the gold was scene. The landscape and the train station have changed to the point where Josh heads to the old track and tunnel to have a look around. Pretty much a den of junk with no significant signs the gold would be hidden inside. A vagrant, yes, gold, no.

With the end of the line being the real end of the line, Josh heads to the mint to see how the coin would have been made as well as get some insight about a recently authenticated coin. Turns out Kruger stamped his own money with his own image and it had some exacting details. The coin will have a specific weight and gold content. Any coin they find will have to match in order to be authentic.

Josh then heads out to meet another treasure who has chosen to investigate a cave system where he's found Kruger era artefacts and weapons. There is some evidence to suggest the gold was hidden within the caves, so Josh suits up to get down and dirty. Dirty indeed as he slugs his way through all sorts of much and narrow spaces. With nothing more than a face full of mud, and perhaps an old coin, Josh makes a layover in an impressive safari hotel.



After a cold beverage and a good night's sleep, Josh meets up with some hunters who found an authentic Kruger gold coin. They are searching across the plains of the Kruger National Park, a nearly 8000 square mile reserve. But you can't just go walking in and digging holes, you need to ask permission. With that, he's off to meet the tribal chief. After a brief talk and Josh getting a tribal spear to protect himself with, he's back on the road and heading deeper into the park.

Not only does Josh meet the treasure hunters, but their armed and military trained entourage. This is no joke, these guys have a heavily armed anti-poaching force coming along for the ride and they armed with enough weapons to make you pucker. Their goal is to stop poachers who still slaughter rhinos for their horns. Not to mention protecting the team from wandering animals. Although, I'm quite convinced they won't shoot the animals.

During the evening, the hunters launch an aerial drone with sensitive cameras to locate metal objects heated by the sun. The military team is also at the ready as this is a prime time for poaching. While there are some noises to be heard under the cover of darkness, everything goes without incident, which is good, because Josh will be spending the night out there.

In the morning, the team goes to each GPS marked location to see what the drone spotted. They pull out a horseshoe, part of a bridle and even an old pistol. They collect quite a few relics from what they believe to be a British used during the Boer War. Not quite the pot of gold they're looking for, but great museum pieces and proof they're looking in the right place.



Is the gold going to be found on plains of the Kruger National Park? Or is it hidden in a cave? Did it still exist at all? It certainly did at one point, there is no doubt about that, but considering the lack of details and the area they need to look in, it seems an almost impossible task to find it. But the lure is millions, possibly billions, so you know they are going to keep at it. And perhaps, if it keeps people out in the plains and thwarts the efforts of poachers, then the hunt won't be in vain.



**BORN TO
DETECT
FORCED TO
WORK**



Incredible moment archaeologists pull out a 2,300-year-old sword and discover it's still shiny and lethal

Chinese archaeologists were surprised to discover that an ancient sword they had unearthed were in near perfect condition.

Last Friday, experts pulled out the blade from its scabbard and realised that the 2,300-year-old relic was shiny and sharp.

The traditional Chinese weapon was found inside an ancient coffin in Henan Province in central China, where the Chinese civilisation is thought to have originated.

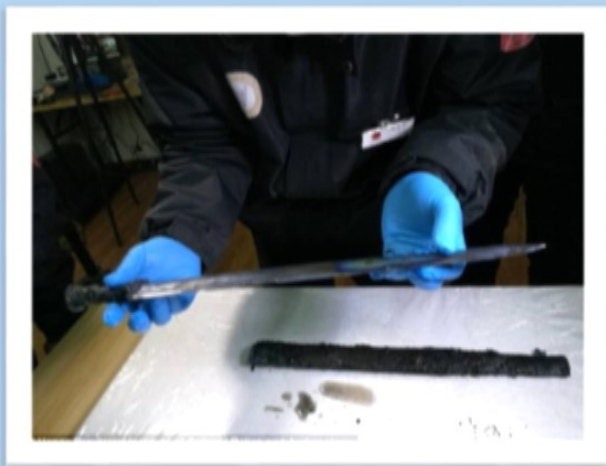

The sword, discovered by archaeologists from Henan Provincial Institute of Cultural Relics and Archaeology, was believed to be from China's Warring States period (475 BC -221 BC).

It had been kept inside the coffin at the left-hand side of its owner.

Archaeologists found the blade in a laboratory as they opened the coffin, which had been excavated from the

No.18 ancient tomb in the ruins of Chengyang city.

After carefully removing the mud-covered sword from the coffin, archaeologists cleaned the sheath before separating the blade from its cover at around 12pm on December 30.

According to a statement from Henan Provincial Institute of Cultural Relics and Archaeology, all experts were surprised when the blade turned out to be in near mint condition.

A member of the staff filmed the moment two archaeologists pulled out the sword and uploaded the footage onto the institute's official account on [Weibo](#) the same day.

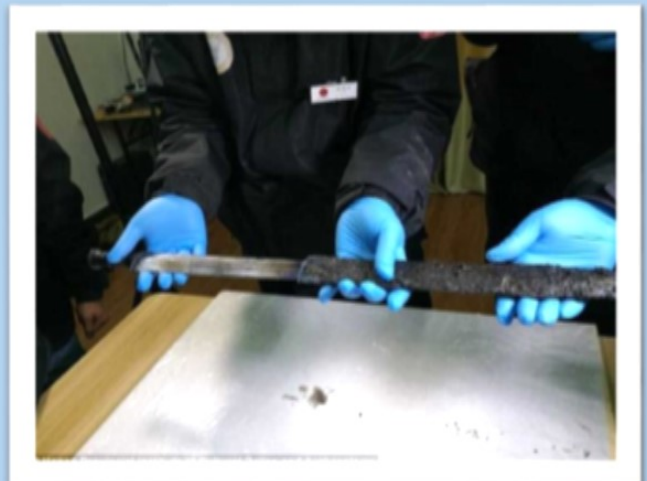

The 12-second clip has been played more than nine million times. Viewers were stunned by ancient Chinese craftsmen's sword-making skills as the weapon was still lethal after more than two millennia

The footage was also widely shared by Chinese media, including [CCTV News](#).

Liu Yong, the deputy supervisor of the Chengyang Protected District, witnessed the sword-drawing ceremony.

He was impressed by the ancient sabre. He said through a poem that though the loyal general had died, his treasured sword was still glittering.

Wu Zhijiang, a team leader from Henan Provincial Institute of Cultural Relics and Archaeology, was one of the two

archaeologists who pulled the sword.

Mr Wu told MailOnline that it was in fact not uncommon to see well-protected ancient swords in the region.

He explained that the ancient tombs from the Chu Kingdom were usually sealed off from the outside world in a humid environment, so weapons would not oxidise easily.

Experts are yet to confirm the identity of the owner of the tomb.



WHY IS CHENGYANG CITY IMPORTANT

- Chengyang ancient city is the best preserved and largest city of the ancient kingdom of Chu (770-223 BC).
- It is located 25km (15.5 miles) north of Xinyang city in Henan Province.
- The city is believed to be first established 2,700 years ago as the barracks of the Chu Kingdom.
- The Chu emperor set up a temporary capital in Chengyang in 278BC after being defeated by the neighbouring Qin kingdom.
- Chengyang continued to be a political, economic, cultural and military centre in the following millennium.



32 ND ANNUAL HUNT FREE STATE CREW 2017



1 - 7 September



Experience the Friendly Free State

WARNING
Metal Detector
In Use



Contact :

Piet Lombard
082 466 5750

lombardpiet03@gmail.com

32 ND ANNUAL HUNT

EASTERN CAPE FRONTIER WAR HUNT CREW

1 - 4 SEPTEMBER 2017

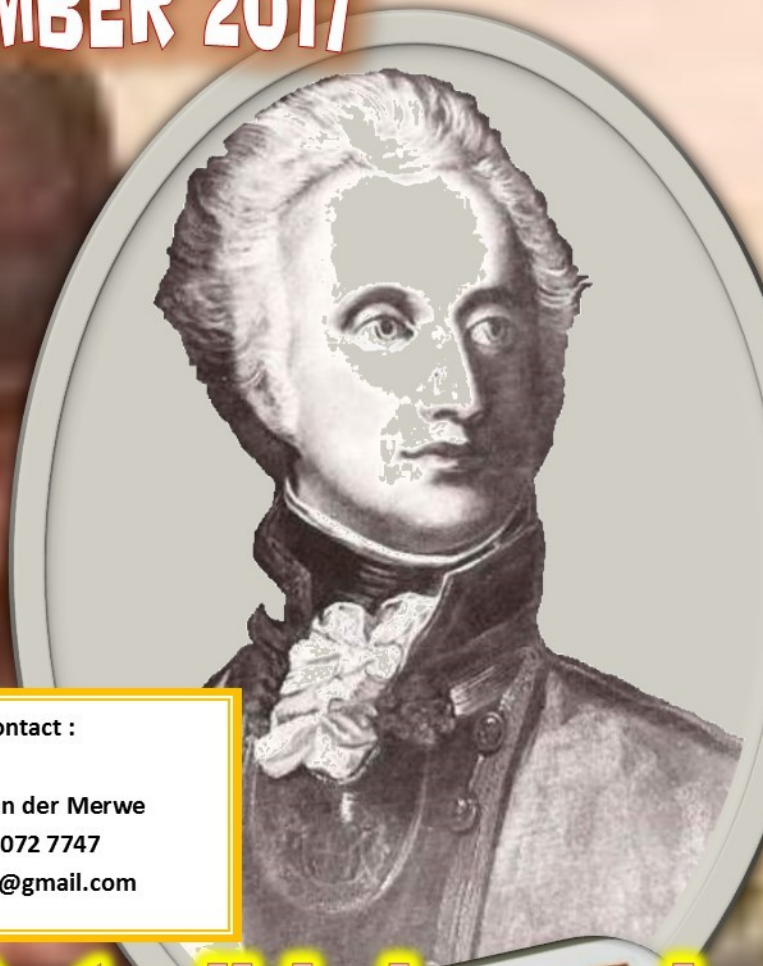

Contact :
Lukas van der Merwe
082 072 7747
hmdrsa@gmail.com

If you got "Guts" join us !





BRING HUNTED-OUT SITES BACK TO LIFE
Impressive recovery speed, target separation and detection depth!



Pro Mode Audio

Proportional Audio and Tone Roll feature allows user to hear subtle changes in target's response to better judge its conductivity, size, shape and depth.

High Res Iron Discrimination™

Allows user to set iron discrim to one of 40 levels for precise ability to separate good targets from trash.

Iron Audio™

Allows the user to hear discriminated iron and to alter the detector's mid-tone signal's range.

All Terrain Versatility

Weatherproof housing designed for dusty, humid, or wet environments; unit can be submerged to a maximum 10-foot depth.

Fast Recovery Speed

Allows greater ability to pick out good targets amongst trash.

More Info: Continuous Coin Depth Indicator to determine target depth. Battery Condition Indicator shows battery life. Graphic Target Analyzer identifies target's conductivity.

PN: 1140560



Instructional DVD Included
PH: 1679900



Land headphones included
PH: 2202400

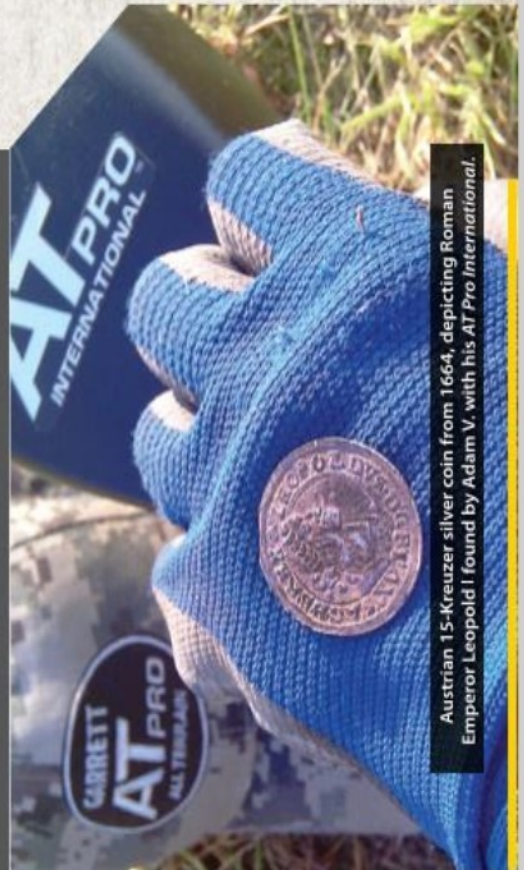

Austrian 15-Kreuzer silver coin from 1664, depicting Roman Emperor Leopold I found by Adam V. with his AT Pro International.

doculam

IDENTIFICATION, SECURITY, SAFETY SOLUTIONS & EVENTS

www.metaldetectors-africa.com



A collection of European finds spanning 800 years of history. Found by AT Pro International user Geoff M. of Austria.

Standard Searchcoil

8.5" x 11" PROformance™ DD coil



Entire detector is fully waterproof to 10 Feet

Ground Balance

Automatic and manually adjustable for improved performance; includes saltwater.

Digital Target ID

0 to 99 Target ID scale offers increased ability to distinguish one target's conductivity from another.

Six Search Modes

Choose from Custom, Coins or Zero discrimination patterns in either the easy-to-learn Standard Mode or in the more advanced Pro Mode. Also includes electronic Pinpointing.



Hi Lukas found these
 on a Old Battlefield
 What relics are these ?
 —————
 They are all
 parts and shrapnel
 of the 15 Pounder
 shell



15 Pounder
 Timer



15 Pounder
 Timer
 Dust Protector
 Transport Plug



15 Pounder
 Part of Timer Ring



SHELL, B.L. B.L.C. OR Q.F. SHRAPNEL 15 P# (MARK VI) L
 FORGED STEEL
 (S 11,236.)

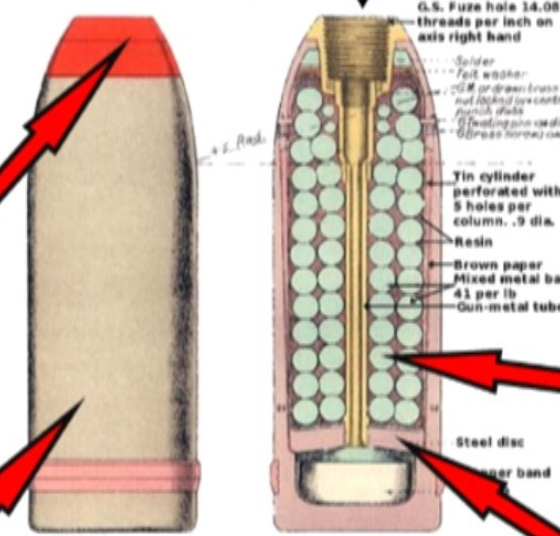

AVERAGE WEIGHT	Lbs.	Oz.
Shell empty with band	13	1 1/2
Bursting charge R.F.G. 2		1 1/2
Fuze T. & P.		13
Mean total weight	14	0



* Contractions initials or recognized trade mark
 † Date of manufacture

PAN OF BASE





The 8 th Field Battery – Firing a 15 Pounder

We have here an excellent picture of the 15 – pounder as the Boers view it through their telescopes when it is about to open fire upon them, and the gun-carriage apparatus are well seen in this illustration. A gun commonly worked by 2 non-commissioned officers and 8 privates. One non-commissioned officer leads the gun , and is in command of it, while gunner No. 2 makes ready and fire. To gunner No 3 is assigned the duty of opening and closing the breech-block and loading, while No 4 has the important duty of aiming. Gunner No.5 brings in the ammunition-box, and the position of No.6 is by the limber or ammunition wagon, these two men having the duty of serving out and bringing up the ammunition for the guns, while the two other men form the reserve and remain with the line of wagons. In the picture – gunners Nos, 1 to 5 are seen at their proper stations, and No. 4 from his place at the trail is lying the gun upon the object to aim at. A picture however, can give little idea of the skill and rapidity with which guns can be worked. Generally certain ammunition wagons are brought forward, and stationed 12 yards in rear of the guns, the horses being led back to the line of wagons, but sometimes the ammunition is taken straight from the limbers, these placed 10-yds. In rear of the guns, with the drivers seated on the horses. The system of supply could not be better



The 8 th Field Battery – Firing a 15 Pounder

We have here an excellent picture of the 15 – pounder as the Boers view it through their telescopes when it is about to open fire upon them, and the gun-carriage apparatus are well seen in this illustration. A gun commonly worked by 2 non-commissioned officers and 8 privates. One non-commissioned officer leads the gun , and is in command of it, while gunner No. 2 makes ready and fire. To gunner No 3 is assigned the duty of opening and closing the breech-block and loading, while No 4 has the important duty of aiming. Gunner No.5 brings in the ammunition-box, and the position of No.6 is by the limber or ammunition wagon, these two men having the duty of serving out and bringing up the ammunition for the guns, while the two other men form the reserve and remain with the line of wagons. In the picture gunners Nos, 1 to 5 are seen at their proper stations, and No. 4 from his place at the trail is lying the gun upon the object to aim at. A picture however, can give little idea of the skill and rapidity with which guns can be worked. Generally certain ammunition wagons are brought forward, and stationed 12 yards in rear of the guns, the horses being led back to the line of wagons, but sometimes the ammunition is taken straight from the limbers, these placed 10-yds. In rear of the guns, with the drivers seated on the horses. The system of supply could not be better

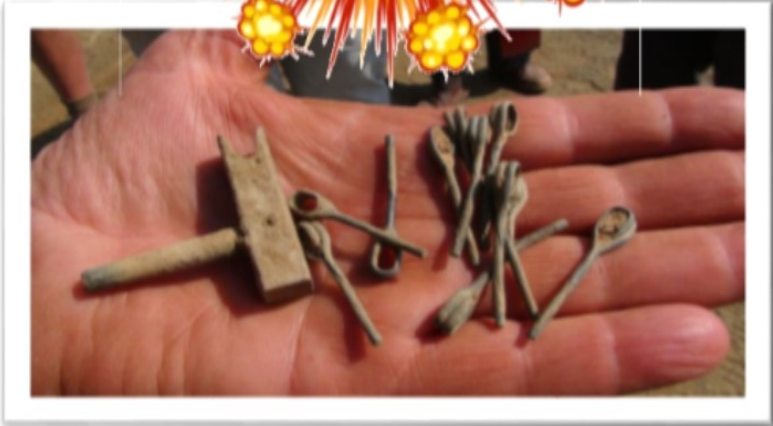
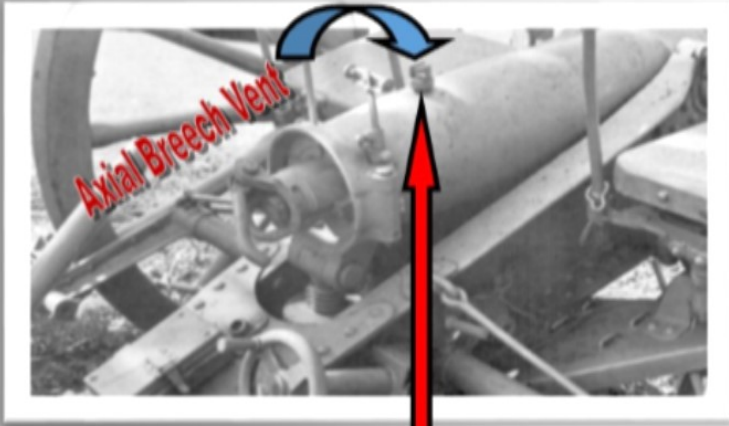

TUBE, FRICTION, T, PUSH. MARK I L. BRASS.

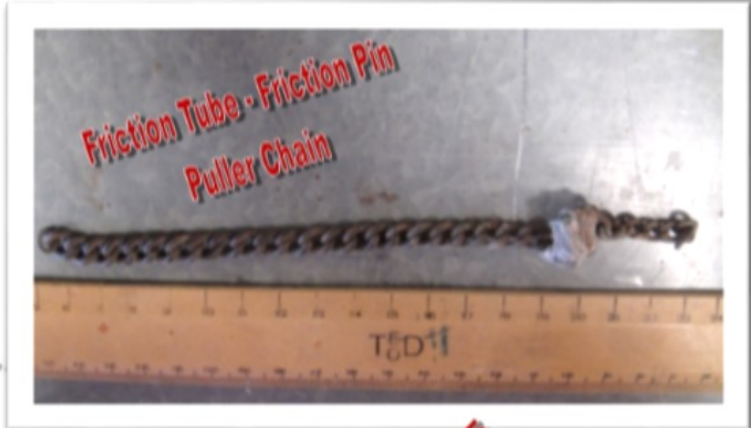
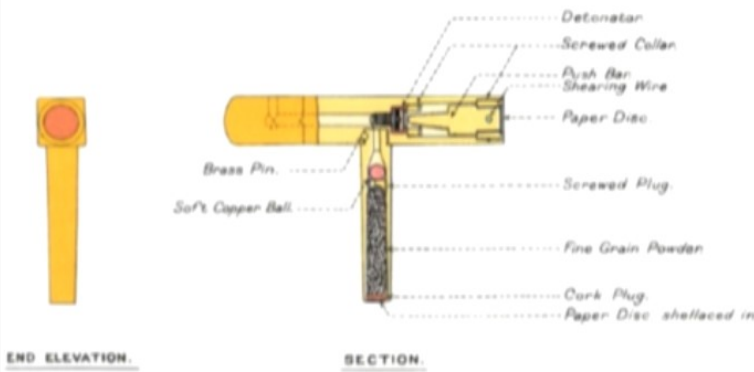

The firing mechanism involved a "push" type T friction tube, which was inserted into the axial breech vent. The crosspiece of the T was positioned pointing upwards. A long layer's guard was added to the left side of the cradle projecting behind the breech. A spring-loaded firing handle was built into the layer's guard. When cocked by pulling back and then releasing, it sprang forward and struck a firing lever on the breech, which translated the forward motion to a downward motion and propelled a firing plunger into the T of the friction tube which in turn ignited the cordite propellant charge.



I WANT YOUR STORY

ALFRED
LEEJE

FOR THE NEXT

"Treasure Talk"